



Lexmark™

Lexmark XC
9235/55 Series
Quick Reference
Guide



Quick Reference

Copying

Making copies

- 1 Load an original document into the ADF tray or on the scanner glass.

Note: To avoid a cropped image, make sure that the original document and output have the same paper size.

- 2 From the home screen, touch **Copy**, and then specify the number of copies.

If necessary, adjust the copy settings.

- 3 Copy the document.

Note: To make a quick copy, from the control panel, press .

Copying on both sides of the paper

- 1 Load an original document into the ADF tray or on the scanner glass.

- 2 From the home screen, touch **Copy > Paper Setup**.

- 3 Adjust the settings.

- 4 Copy the document.

Copying multiple pages onto a single sheet

- 1 Load an original document into the ADF tray or on the scanner glass.

- 2 From the home screen, touch **Copy > Pages per Side**.

- 3 Adjust the settings.

- 4 Copy the document.

Faxing

Sending a fax

Using the control panel

- 1 Load the original document into the ADF tray or on the scanner glass.

- 2 From the home screen, touch **Fax**, and then enter the needed information.

- 3 If necessary, configure other fax settings.

- 4 Send the fax job.

Using the computer

Note: Make sure that the Universal Fax driver is installed.

For Windows users

- 1 With a document open, click **File > Print**.

- 2 Select the printer, and then click **Properties, Preferences, Options, or Setup**.

- 3 Click **Fax > Enable fax**, and then enter the recipient number.

- 4 If necessary, configure other fax settings.

- 5 Send the fax job.

For Macintosh users

- 1 With a document open, choose **File > Print**.

- 2 Select the printer and enter the recipient number.

- 3 If necessary, configure other fax settings.

- 4 Send the fax job.

E-mailing

Sending an e-mail

Using the control panel

- 1 Load an original document into the ADF tray or on the scanner glass.

- 2 From the home screen, touch **E-mail**, and then enter the needed information.

Note: You can also enter the recipient using the address book or shortcut number.

- 3 If necessary, configure the output file type settings.

- 4 Send the e-mail.

Using the shortcut number

- 1 From the control panel, press #, and then enter the shortcut number using the keypad.

- 2 Send the e-mail.

Printing

Printing from a computer

Note: For labels, card stock, and envelopes, set the paper size and type in the printer before printing the document.

- 1 From the document that you are trying to print, open the Print dialog.

- 2 If necessary, adjust the settings.

- 3 Print the document.

Printing confidential and other held jobs

For Windows users

- 1 With a document open, click **File > Print**.

- 2 Click **Properties, Preferences, Options,** or **Setup.**
- 3 Click **Print and Hold.**
- 4 Select **Use Print and Hold,** and then assign a user name.
- 5 Select the print job type (Confidential, Repeat, Reserve, or Verify).
If the print job is confidential, then enter a four-digit PIN.
- 6 Click **OK** or **Print.**
- 7 From the printer home screen, release the print job.
 - For confidential print jobs, navigate to:
Held jobs > select your user name > **Confidential** > enter the PIN > select the print job > configure the settings > **Print**
 - For other print jobs, navigate to:
Held jobs > select your user name > select the print job > configure the settings > **Print**

For Macintosh users

- 1 With a document open, choose **File > Print.**
If necessary, click the disclosure triangle to see more options.
- 2 From the print options or Copies & Pages menu, choose **Job Routing.**
- 3 Select the print job type (Confidential, Repeat, Reserve, or Verify).
If the print job is confidential, then assign a user name and a four-digit PIN.
- 4 Click **OK** or **Print.**
- 5 From the printer home screen, release the print job.
 - For confidential print jobs, navigate to:
Held jobs > select your user name > **Confidential** > enter the PIN > select the print job > configure the settings > **Print**
 - For other print jobs, navigate to:
Held jobs > select your user name > select the print job > configure the settings > **Print**

Canceling a print job

From the printer control panel

- 1 From the home screen, touch **Job Queue.**
Note: You can also access this setting by touching the top section of the home screen.

- 2 Select the job to cancel.

From the computer

- 1 Depending on the operating system, do either of the following:
 - Open the printers folder, and then select your printer.
 - From the System Preferences in the Apple menu, navigate to your printer.
- 2 Select the job to cancel.

Loading paper

Loading trays

CAUTION—TIPPING HAZARD: To reduce the risk of equipment instability, load each tray separately. Keep all other trays closed until needed.

- 1 Pull out the tray.

Note: Do not remove trays while the printer is busy.



- 2 Adjust the guides to match the size of the paper that you are loading.

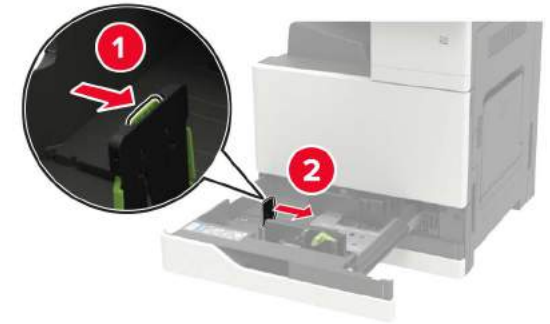

3 Flex, fan, and align the paper edges before loading.

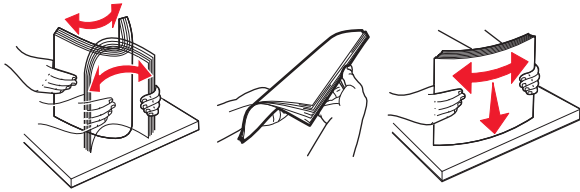

4 Load the paper.

- When using letterhead, do either of the following:

Without an optional finisher	With an optional finisher
<p>One-sided printing</p>	<p>One-sided printing</p>
<p>Two-sided printing</p>	<p>Two-sided printing</p>
<p>One-sided printing</p>	<p>One-sided printing</p>

Without an optional finisher	With an optional finisher
<p>Two-sided printing</p>	<p>Two-sided printing</p>

- Load pre-punched paper with the holes toward the front or left side of the tray.
- Do not slide paper into the tray.
- To avoid paper jams, make sure that the stack height is below the maximum paper fill indicator.

5 Insert the tray.

If loading a paper type other than plain, from the control panel, set the paper size and paper type to match the paper loaded.

Loading the 2500-sheet tray

The 2500-sheet tray supports only one paper size, either A4 or letter. To check the supported paper size, pull out the tray and then locate the size indicator on the bottom of the tray.

CAUTION—TIPPING HAZARD: To reduce the risk of equipment instability, load each tray separately. Keep all other trays closed until needed.

1 Pull out the tray.



Notes:

- To avoid paper jams, do not remove trays while the printer is busy.
- To avoid errors, make sure that the transfer guide is always at the left side of the tray.

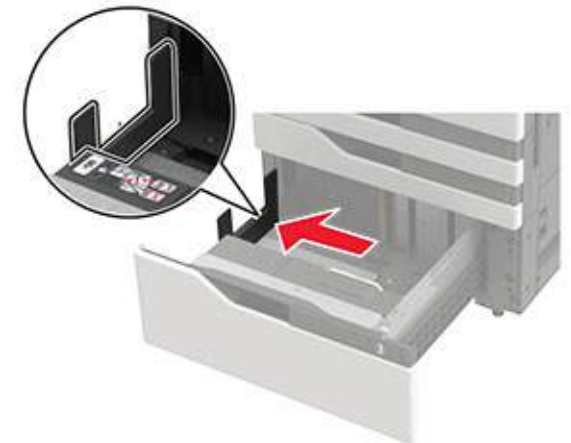

2 Flex, fan, and align the paper edges before loading.

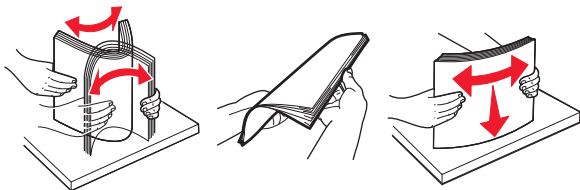

3 Load the paper stack on the right side, and then load the paper stack on the left side.

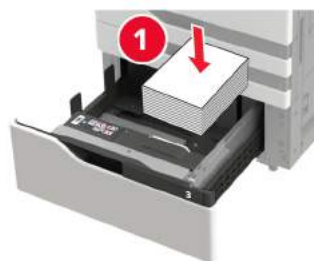

- Make sure that the stack height is below the maximum paper fill indicator on each side of the tray.
- Load letterhead faceup for one-sided printing.
- Load letterhead facedown for two-sided printing.
- Make sure that the paper stacks do not cross the divider. Push each paper stack against the sides of the tray.



4 Insert the tray.

5 From the control panel, navigate to: **Settings > Device > Maintenance > Configuration Menu > Tray Configuration > Size Sensing.**

6 Select the tray and paper size.

Loading the 3000-sheet tray

The 3000-sheet tray supports only one paper size, either A4 or letter.

 **CAUTION—TIPPING HAZARD:** To reduce the risk of equipment instability, load each tray separately. Keep all other trays closed until needed.

1 Open door F, and then lift the feed roller.

Warning—Potential Damage: To avoid damage and poor performance, do not touch the feed rollers.

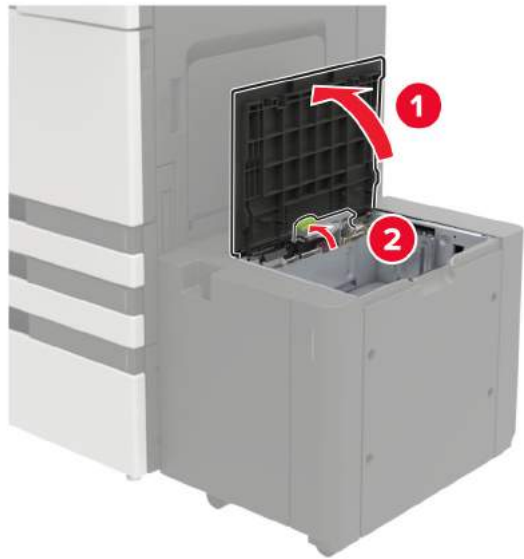

2 Flex, fan, and align the paper edges before loading.

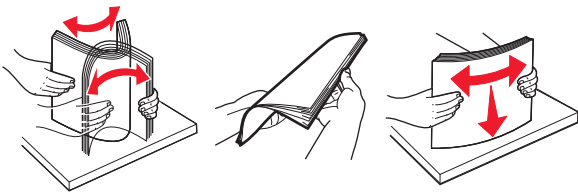

3 Load the paper stack with the printable side facedown.

- Load letterhead facedown for one-sided printing.
- Load letterhead faceup for two-sided printing.

- To avoid paper jams, make sure that the stack height is below the angle on the frame.

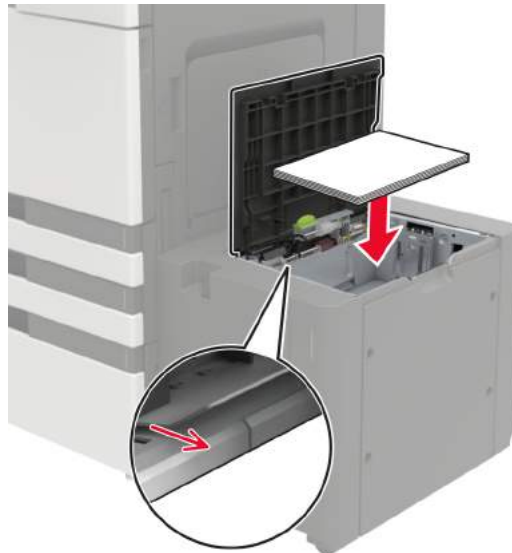

4 Lower the feed roller, and then close the door.

5 From the control panel, navigate to: **Settings > Device > Maintenance > Configuration Menu > Tray Configuration > Size Sensing.**

6 Select the tray and paper size.

Loading the multipurpose feeder

1 Open the multipurpose feeder.



- Adjust the guide to match the size of the paper that you are loading.

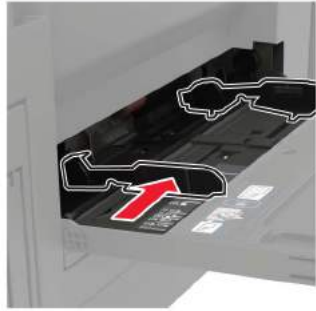

- Flex, fan, and align the paper edges before loading.

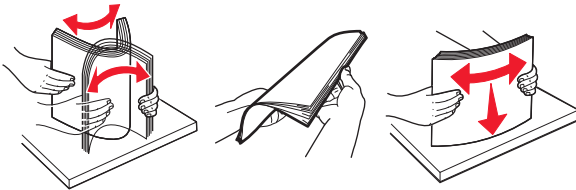

- Load the paper or specialty media.
When using letterhead, do either of the following:

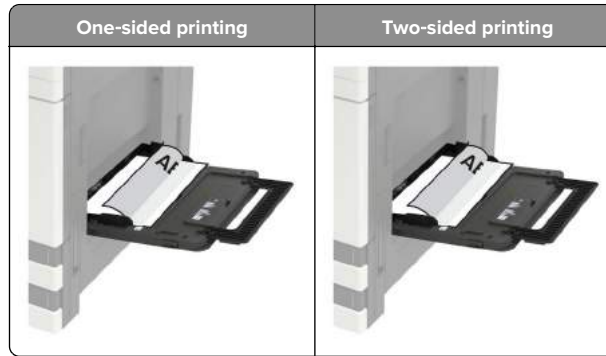
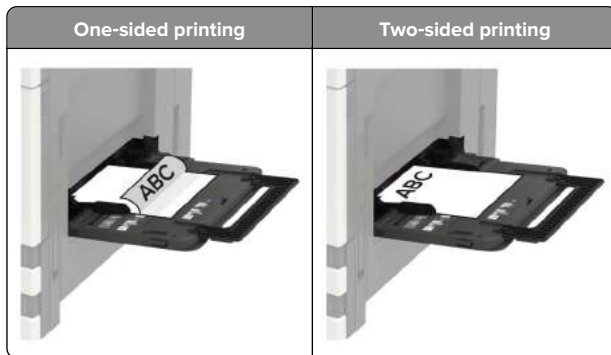

Warning—Potential Damage: When using envelopes, do not use envelopes with stamps, clasps, snaps, windows, coated linings, or self-stick adhesives.

- From the control panel, set the paper size and paper type to match the paper loaded.

Setting the size and type of the specialty media

The trays automatically detect the size of plain paper. For specialty media like labels, card stock, or envelopes, do the following:

- From the home screen, navigate to:
Settings > Paper > Tray Configuration > Paper Size/Type > select a paper source
- Set the size and type of the specialty media.

Maintaining the printer

Replacing a toner cartridge

- Open door A.

- Remove the toner cartridge.

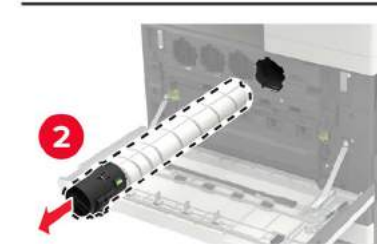
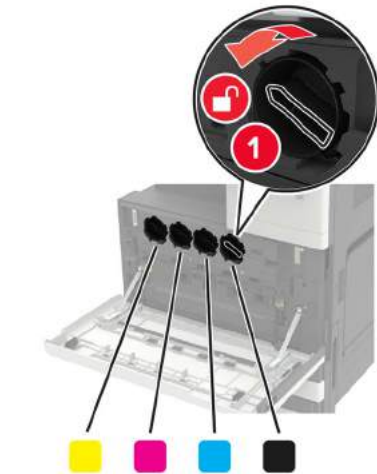

- Unpack the new toner cartridge.

4 Shake the toner cartridge three times.

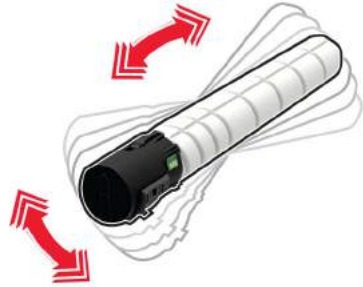

5 Insert the new toner cartridge.

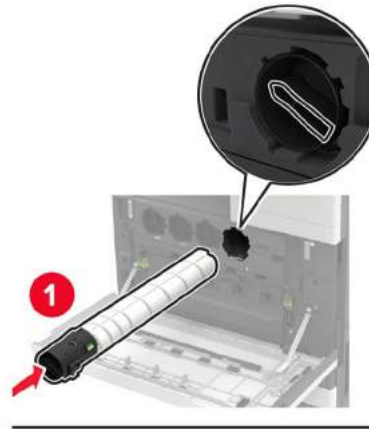

6 Remove the waste toner bottle.

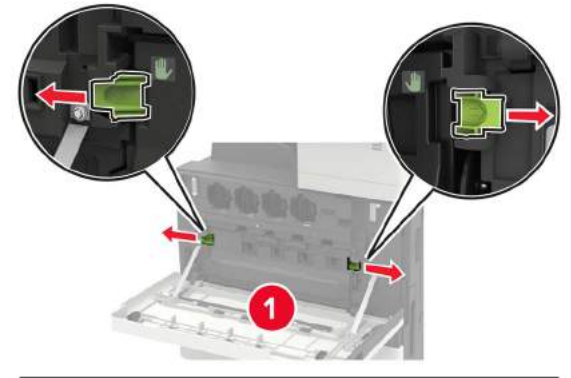

7 Using the printhead wiper, clean the printhead lens.

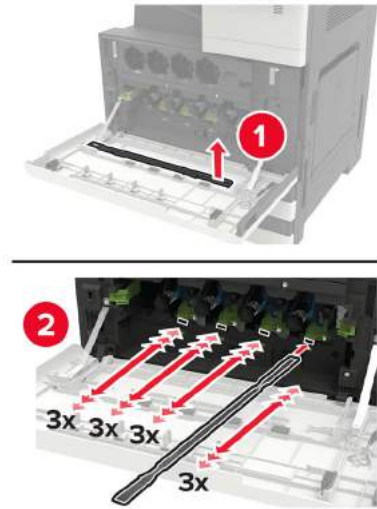

8 Insert the wiper back into place.

9 Insert the waste toner bottle, and then close the door.

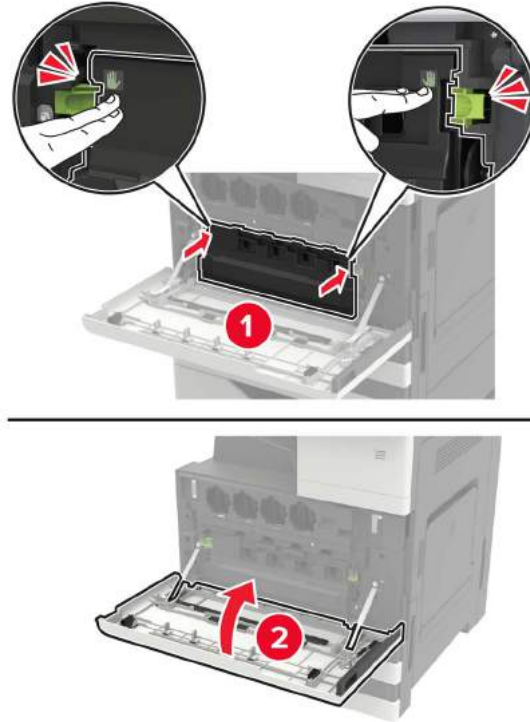

Cleaning the scanner

1 Open the scanner cover.

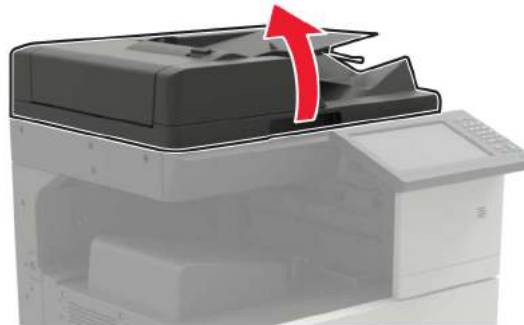

2 Using a damp, soft, lint-free cloth, wipe the following areas:

- ADF glass



- ADF glass pad



- Scanner glass



- Scanner glass pad

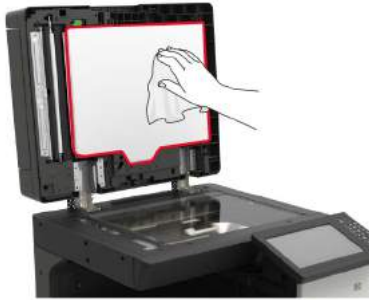

- 3 Close the scanner cover.

Clearing jams

Avoiding jams

Load paper properly

- Make sure that the paper lies flat in the tray.

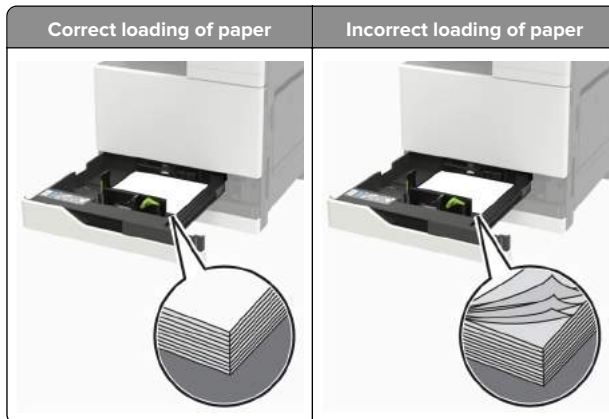

- Do not load or remove a tray while the printer is printing.
- Do not load too much paper. Make sure that the stack height is below the maximum paper fill indicator.

- Do not slide paper into the tray. Load paper as shown in the illustration.



- Make sure that the paper guides are positioned correctly and are not pressing tightly against the paper or envelopes.
- Push the tray firmly into the printer after loading paper.

Use recommended paper

- Use only recommended paper or specialty media.
- Do not load paper that is wrinkled, creased, damp, bent, or curled.
- Flex, fan, and align the paper edges before loading.

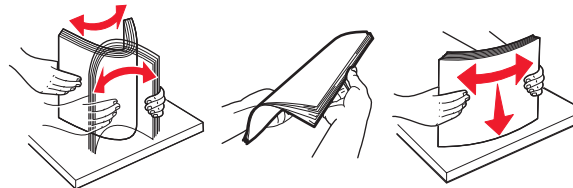

- Do not use paper that has been cut or trimmed by hand.
- Do not mix paper sizes, weights, or types in the same tray.
- Make sure that the paper size and type are set correctly on the computer or printer control panel.
- Store paper according to manufacturer recommendations.

Paper jam in the automatic document feeder

- 1 Remove all original documents from the ADF tray.

- 2 Open door B.

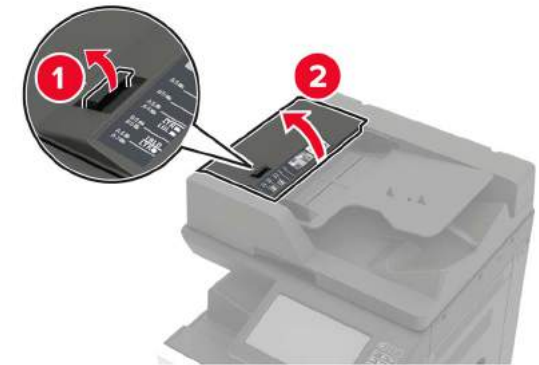

- 3 Remove the jammed paper.

Note: Make sure that all paper fragments are removed.

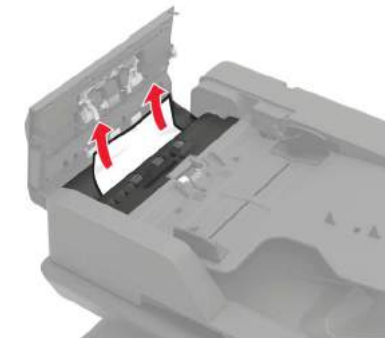

- 4 Close the door.

5 Open door B1.



6 Remove the jammed paper.

Note: Make sure that all paper fragments are removed.

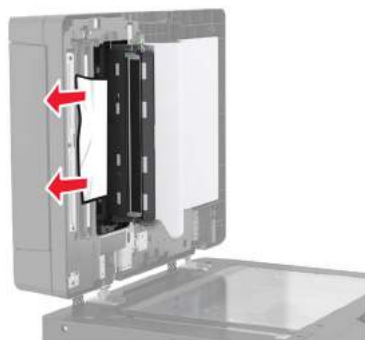

7 Close the door.

Paper jam in the multipurpose feeder

1 Remove paper from the multipurpose feeder.

2 Remove the jammed paper.

Note: Make sure that all paper fragments are removed.



3 Open door C to remove any paper fragments.

CAUTION—HOT SURFACE: The inside of the printer might be hot. To reduce the risk of injury from a hot component, allow the surface to cool before touching it.

Notes:

- Make sure that the door does not hit any cable attached to the printer.
- If a 3000-sheet tray is installed, then slide the tray to the right to open the door.

4 Close the door.

5 Flex, fan, and align the paper edges before loading.

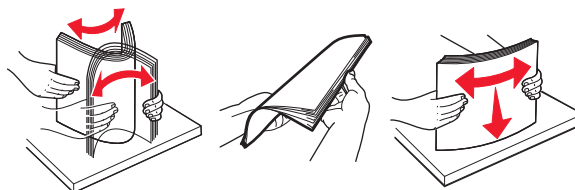

6 Reload paper.

Paper jam in door C

1 Open door C.

CAUTION—HOT SURFACE: The inside of the printer might be hot. To reduce the risk of injury from a hot component, allow the surface to cool before touching it.

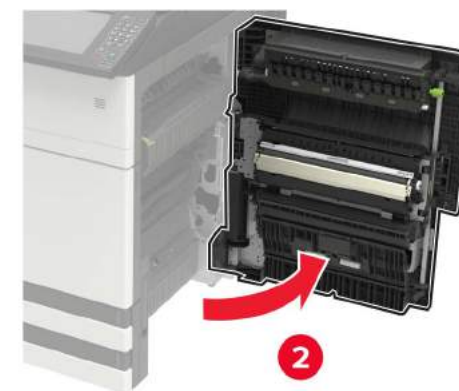

Notes:

- Make sure that the door does not hit any cable attached to the printer.
- If a 3000-sheet tray is installed, then slide the tray to the right to open the door.

2 Remove the jammed paper from any of the following locations.

Note: Make sure that all paper fragments are removed.

- Fuser area

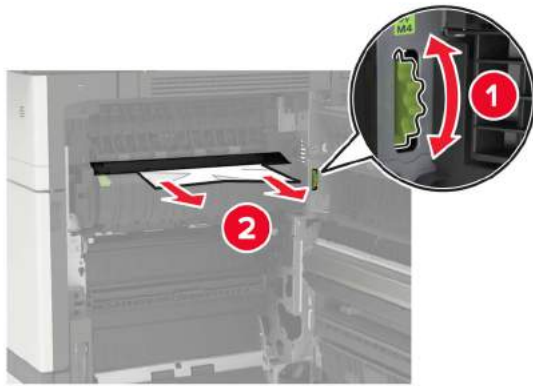

- Below the fuser area

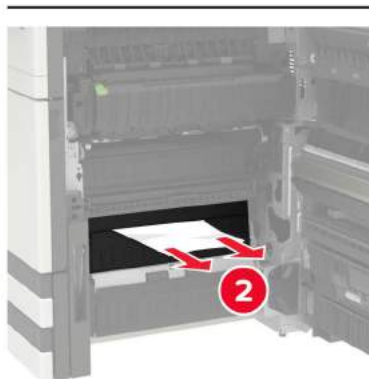
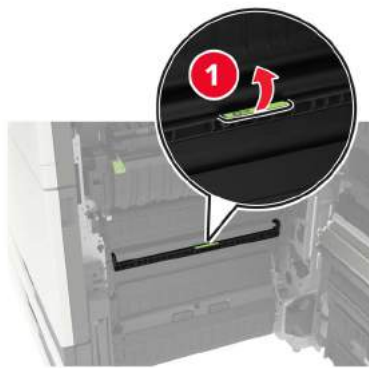

- Duplex area

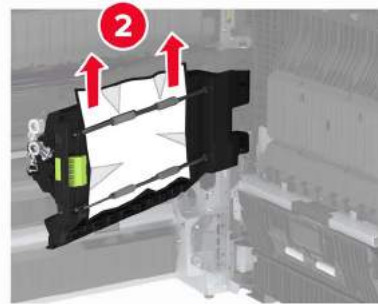

- Above the duplex area



3 Open the standard trays, and then remove the jammed paper.

Note: Make sure that all paper fragments are removed.



4 Close the trays, and then close the door.

Paper jam in door D

1 Open door D, and then remove the jammed paper.



Notes:

- If a 3000-sheet tray is installed, then slide the tray to the right to open the door.
- Open door C to make sure that all paper fragments are removed, and then close the door.

2 Open the optional tray, and then remove the jammed paper.

Note: Make sure that all paper fragments are removed.



3 Close the tray, and then close the door.